

## “Dose of Wisdom”

### Stewardship Under the Cross God's Word on How We Use His Gifts

As we begin this new year, I would like to focus on the topic of Stewardship. This is going to be a yearlong emphasis to look at what stewardship is and how it is done. This is taken from resources we are given through The Lutheran Church--Missouri Synod office of Stewardship Ministry and the Coordinator Heath Curtis. This is one of many options to choose from to catechize on Stewardship. So I am using what they have for me to use, but I want to make sure I am writing it and presenting it to you in such a way as it fits our congregation, Zion Lutheran Church, Arcadia, Iowa. God has blessed us with great gifts here, now we can use them and give them back to Him.

### What is Stewardship?

Christian stewardship is the faithful management of our financial resources and all we have. It begins with the understanding that all we have is God's (Ps. 24:1 “The earth is the LORD's, and everything in it, the world, and all who live in it”) and that "we brought nothing into the world, and we cannot take anything out of the world" (1Tim 6:7). Since all we have is God's, we should use it for His purposes. God's purpose for us in our lives is expressed in the various vocations, or callings, that we have. So, for example, a father and mother use their income to feed, clothe, and protect their children. Besides the vocations that each of us have in our family life and in society, we are also all Christians and members of this parish. How do we use our income faithfully in regard to this vocation? To learn this we must look to God's Word.

**Deuteronomy 8:17-18** <sup>17</sup> *You may say to yourself, My power and the strength of my hands have produced this wealth for me.* <sup>18</sup> *But remember the LORD your God, for it is he who gives you the ability to produce wealth, and so confirms his covenant, which he swore to your forefathers, as it is today.*

**Luke 16:13** *Jesus said, No servant can serve two masters. Either he will hate the one and love the other, or he will be devoted to the one and despise the other. You cannot serve both God and Money."*

**Matthew 6:19-21** *Jesus said, "Do not store up for yourselves treasures on earth, where moth and rust destroy, and where thieves break in and steal. But store up for yourselves treasures in heaven, where moth and rust do not destroy, and where thieves do not break in and steal. For where your treasure is, there your heart will be also."*

**Malachi 3:8-9** *"Will a man rob God? Yet you rob me. But you ask, 'How do we rob you?' In tithes and offerings. <sup>9</sup> You are under a curse-- the whole nation of you-- because you are robbing me.*

**2 Corinthians 8:7, 9:6-8** *But just as you excel in everything-- in faith, in speech, in knowledge, in complete earnestness and in your love for us --see that you also excel in this grace of giving. . . The point is this: he who sows sparingly will also reap sparingly, and he who sows bountifully will also reap bountifully. Each one must do as he has made up his mind, not reluctantly or under compulsion, for God loves a cheerful giver. And God is able to provide you with every blessing in abundance, so that you may always have enough of everything.*

**What does this mean?**

*Your heart always goes where you put God's money. Stewardship is not an optional subcategory of the Christian life; it is the living out of a Christian's dependence on God.* As such, faith and finances are inseparable. True joy is found not in storing up the things of this world, for the things of this world won't last. True joy is found in clinging to Christ who poured out His life for you on the cross and now gives you His Life in Baptism, Absolution, and the Lord's Supper. The things of this world are temporarily given to us by God to see and we will be called to account for how we manage the Owner's things (*Rom. 14:10-12, 2 Cor. 5:10*).

**THIS NOVEMBER: Prayerfully Consider Your Giving**

In the month of Thanksgiving when we celebrate the Harvest Supper at Zion, prayerfully consider your giving to God's work in His Church. Are you faithfully giving a *first-fruits tithe (10%)* of your income to the work of God? Are you, as St. Paul says, "excelling in this grace of giving"? If not, why not? In next month's newsletter we'll consider more of what God says about Stewardship – specifically more about tithing (the Biblical practice of giving a tenth of our income to God's work in the Church) – and provide steps for planning your giving.

*God's Blessings in Christ,  
Pastor Dose*

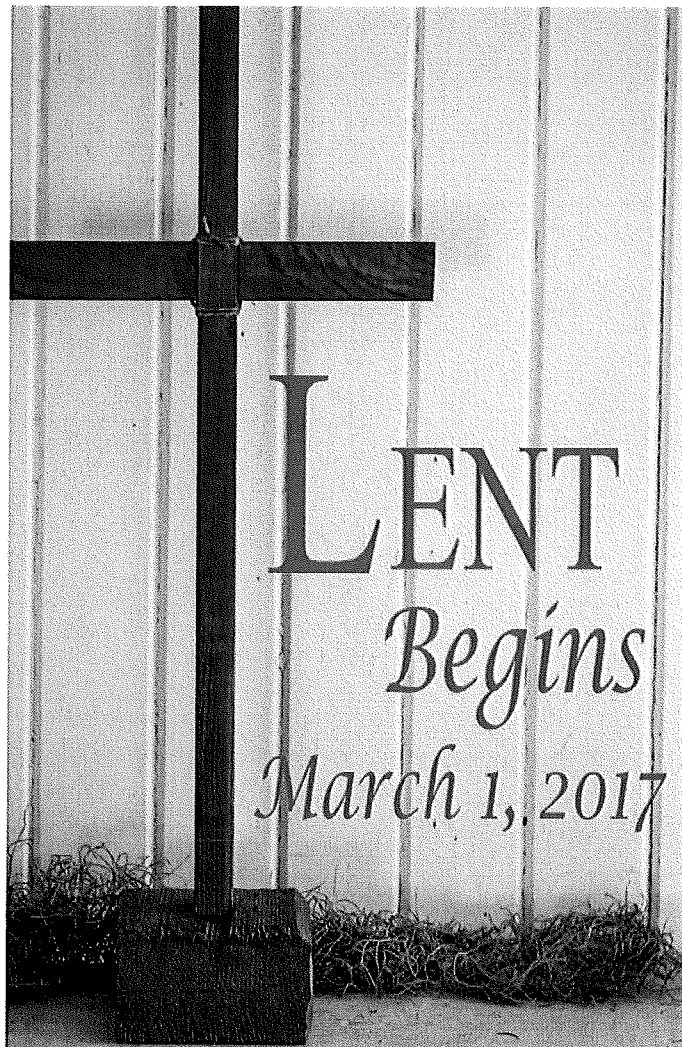



# Friendship Sunday --- February 12, 2017

## WE WANT YOU TO INVITE SOMEONE!

**Invite a Friend  
to Church**

You may not have done this before – but this year we want you to! Consider a neighbor, a friend, a relative, someone with whom you work, or see occasionally. They could be new to the area or someone who has been around for years. God wants you to invite them. The front entry of our church with its stain glass windows were designed to make people look, wonder, and want to come in – but the doors alone cannot do this. **WE'D LIKE YOU TO TAKE THE FIRST STEP**; the Holy Spirit will help. Offer to pick them up if there is any way you could work this out.

Come, join us and bring a friend or two! You'll learn some things which may surprise you and all those who come will not go away hungry.

**FRIENDSHIP ABLAZE! MEANS BUILDING FRIENDSHIPS:** Perhaps there is an acquaintance in your life who needs you to build a stronger friendship with him/her. Maybe it is your mechanic, your hair dresser, a neighbor, or a person at work. You are someone who can share the greatest Friend any of us will ever have. Now is the time to intentionally build that friendship. Spend time with that person. Remember birthdays, anniversaries. Share your times of joy and celebration with that person. Seek ways to help and encourage your friendship. This is how we set our friendships *Ablaze!*



We would like to welcome into baptized membership Cooper Lay McNelly son of Matthew McNelly and Nicole Lay. Cooper was baptized here at Zion on January 15th.



Work Hard,  
Do Your Best,  
Keep Your Word,  
Never Get Too Big For Your Britches,  
Trust In God  
And Never Forget a Friend

## God's conversation hearts

Those familiar conversation hearts that show up every February can be more than just trite romantic or friendly sayings. Use them to remind you — or to teach a child — of the greatest love of all: God's love for us, which empowers our love for others. For example:

♥ TRUE LOVE: What love is truer than giving up one's only Son so people might have everlasting life? (John 3:16).

♥ BE MINE: Jesus knows us intimately, as a shepherd knows his sheep. No one can snatch us from him (John 10:27-29).

♥ FOREVER: God loves us with an "everlasting love" (Jeremiah 31:3).

♥ LOVE ME: The greatest commandment is to love God with our whole being (Luke 10:27).

♥ TRUST ME: "Let not your hearts be troubled." We can count on Jesus, now and for eternal life (John 14:1-3).

♥ SWEET TALK: God's words are sweeter than honey (Psalm 119:103).

♥ BE GOOD: We show our love for Christ by keeping his commands (John 14:15).

♥ CALL ME: God longs to be in fellowship with us. We can talk to him anytime in prayer (Jeremiah 33:3).

♥ FRIENDS: The greatest love involves laying down your life for your friends (John 15:13) — precisely what Jesus did.

♥ #1: "We love because [God] first loved us" (1 John 4:19).

The gift that gives



Love ever gives,  
forgives, outlives  
and ever stands  
with open hands.

And while it lives, it gives.  
For this is love's prerogative —  
to give, and give, and give.

—John Oxenham

Character doesn't save

A tombstone in an old London churchyard  
reveals the deceased knew that only Jesus saves:

If friendship, kindness, truth, goodwill and  
love

Could prove a passport to the realms  
above,

The soul that tenanted this mouldering  
frame

To God's right hand might justly lay a  
claim.

But her own works she scorned as worth-  
less dust:

Her Savior's merits were her only trust.

# February Birthdays & Anniversaries

SUNDAY	MONDAY	TUESDAY	WEDNESDAY	THURSDAY	FRIDAY	SATURDAY
			1 Camille Mumm	2 Jeremy Ewoldt	3 Tracy Ehlers Spencer Owen Denise Ragaller Kendyl Riesberg Grant Wilken	4 Olivia Mau
5 Cassie Neumann Paulette Von Gian Leonard & Marilee Reetz	6	7 Hannah Kraus Roger Lee Nolan Vetter	8	9 Donna Schurke	10 Dane Dirks Mary Lou Kraus	11 Denny Maasen Marilyn Mumm
12	13 Al & Sandy Hunter	14 Shayna Hinners Trama Vetter Dawn Winey Jacob Wittrock Roger & Joyce Lee	15 Dylan Vetter Jim & Patty Vetter	16 Ryan Middleton	17 Brandon Hinners Lilly Julin Lacey Middleton Ann Whitaker	18 Wyatt Ragaller
19 Tyler Middleton Emily Witt	20 Jane Hagge	21	22 Mary Erps Brian Hausman	23	24 Janice Wilken	25 Doug Kuhl Tony Mumm Gavin Thiedeman
26	27	28 Wilbert Ehlers Emmalee Julin Emily Weller Randy & Mary Bruhn				

The church council is asking for the congregations help with ideas to help us in meeting our day to day expenses. We are finding it more difficult each year to do so. If you have any ideas to increase giving, or decrease expenses, please write them down below, and drop them off at the church office or give them to one of the council members. As a reminder our Endowment fund has been a huge blessing, but cannot, as per our constitution, be used for day to day operating expenses. We very much want and welcome the congregations input!!

---

---

---

---

---

---

---

---

---

---

---

---

## JESUS, MY SPECIAL FRIEND

When the troubles of this world crowd my  
mind, I turn to Jesus every time

I tell Him all that in my heart  
So he can do his work of art  
On my thoughts, my fears and doubts  
He dries my tears and drives evil out  
He has never told a secret yet  
An He understands me you can bet

He treats me go gentle and so kind and  
Holds me close to Him at times  
Sometimes I can almost hear him whis-  
per "I love you, please don't cry" He gives  
me strength to carry on  
When I have thought and cried till dawn  
He is the very best kind of friend  
On Him I can always depend

He is never too busy to listen to me and  
He fills my heavy heart with glee  
I hope I can be the kind of friend to Him  
as He has always been to me

*Kay Harrison*



*Jesus*  
*Our True Friend*



*"A friend loves*  
AT ALL TIMES."

PROVERBS 17:17, NRSV

## A Friend in Jesus"

Who could I turn to?  
There's no one, but you,  
My Savior who loves me,  
Guides me each day through.

My Savior, who's there,  
When I need a friend,  
Always ready and able,  
For my problems, to tend.

My Savior, who's there,  
When I'm down sick or crying,  
Even when my life's path,  
Full of knots needs untying.

What could I say?  
Your love shines forever,  
Burning in my heart,  
Lighting any stormy weather.

What back, could I give?  
But just words, I love you  
And what back might I ask,  
Knowing you love me too.

Thank you, my Savior,  
You're my real true friend,  
You gave your life for me,  
And on you I can depend.

ChrisRS ©1986  
"All Rights Reserved"

## Refocus for Lent

Give up complaining — focus on gratitude.  
Give up harsh judgments — think kind thoughts.  
Give up worry — trust God to provide.  
Give up discouragement — be full of hope.  
Give up bitterness — turn to forgiveness.  
Give up hatred — return good for evil.  
Give up anger — be more patient.  
Give up pettiness — become mature.  
Give up jealousy — pray for trust.  
Give up gossiping — control your tongue.  
Give up sin — turn to virtue.  
Give up giving up — persevere.

—Author unknown

## Mealtime as a family

Amid busy and varied schedules, many families find a way to sit down together for dinner regularly. Family-health advocates describe the benefits: an increased sense of unity, children sharing news and feeling listened to, and the physical perks of a planned, seated meal.

In Scripture, many great encounters between people and God happen around meals. Abraham and Sarah prepare a meal for three guests who turn out to be angels (Genesis 18). God instructs the Hebrew slaves to eat a special meal together before their delivery from Egypt (Exodus 12); every year since, Jews have celebrated the Passover feast. Elijah is strengthened with food served by an angel (1 Kings 19). Jesus shares meals not only with religious leaders but with “sinners” (e.g., Matthew 9). Jesus’ Last Supper with his disciples before his death has become one of the church’s sacraments and a “foretaste” of the heavenly banquet to come.

When Christian families eat together, it’s a holy time in God’s presence, just as when the church shares Holy Communion — a true fellowship dinner!

## “Teach us to love”

O God, perfect us in love,  
That we may conquer all selfishness and hatred of others;  
Fill our hearts with thy joy,  
And shed abroad in them thy peace which passeth understanding;  
That so those murmurings and disputings  
To which we are too prone may be overcome.  
Make us long-suffering and gentle,  
And thus subdue our hastiness and angry tempers,  
And grant that we may bring forth the blessed fruits of the Spirit,  
To thy praise and glory, through Jesus Christ our Lord. Amen.

—Rev. Henry Alford (1810-1871)



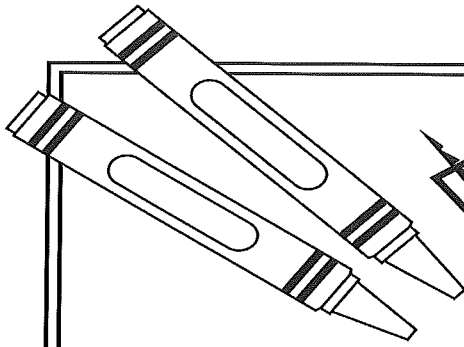

# PUZZLE

## Conversation hearts

The world encourages people to look out for themselves and seek success, but in Micah 6:8, God tells us to live differently.

*Directions: Put the conversation hearts in the correct order by writing the words on the lines below. Hint: Capitalization and quotation marks are included.*

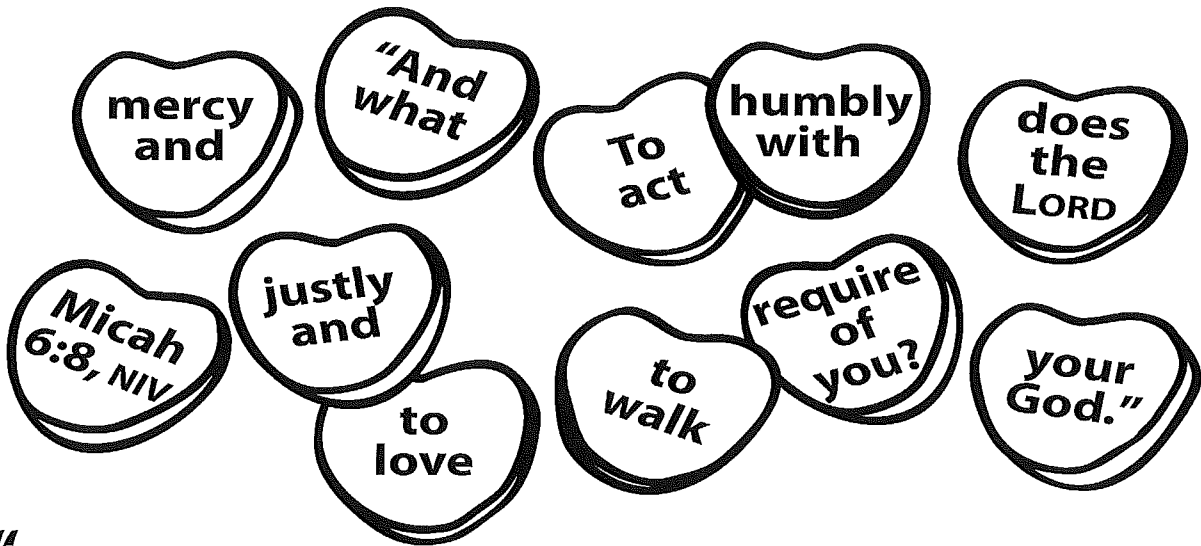

"

\_\_\_\_\_

\_\_\_\_\_ ? \_\_\_\_\_

\_\_\_\_\_

\_\_\_\_\_

\_\_\_\_\_ " \_\_\_\_\_ 6:8 \_\_\_\_\_

Answer: "And what does the LORD require of you? To act justly and to love mercy and to walk humbly with your God." Micah 6:8, NIV



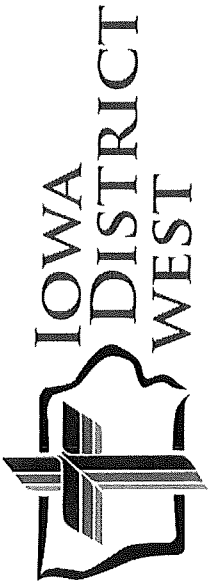

THE LUTHERAN CHURCH-MISSOURI SYNOD

## Planting Together February 2017

409 Kenyon Road, Suite B — Fort Dodge, Iowa 50501  
515-576-7666 Fax 515-576-2323 [www.idw/lcms.org](http://www.idw/lcms.org)  
Contact email: [sue.light@idw/lcms.org](mailto:sue.light@idw/lcms.org)

### On a Mission to Support Christ's Mission!

#### United in Christ

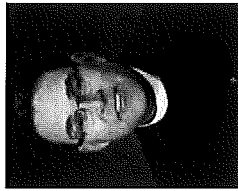

The mission statement of Iowa District West is; On a Mission to Support Christ's Mission. That mission takes place in your congregations and communities. Christians see our unity with each other on the Cross. Jesus takes on Himself your sins and mine. That means all of us are there on Calvary. Connected to Christ and therefore connected to each other. Think for just a moment how very intimate that connection is. Jesus dies a horrible and painful death so that He might exchange His righteous perfection for our sin. Unity lies at the very heart of the Gospel.

Jesus wants this unity to be about Him. We are to be united around Jesus, the real Jesus – who comes to us in the bread and wine of the Lord's Supper offering His Body and Blood for the forgiveness of our sins and strengthening our faith. We are united to Christ in the preaching of the Gospel. He comes to us in the words of absolution, "I forgive you." This takes place in your congregations with your pastors, teachers and fellow members joining together to demonstrate Christ-like love and charity in your communities.

Rev. Dr. Steve Turner, President  
[steve.turner@idw/lcms.org](mailto:steve.turner@idw/lcms.org)

For more information on Iowa District West activities,  
view *The Messenger* at [www.idw/lcms.org/publications.php](http://www.idw/lcms.org/publications.php).

#### Someone hospitalized in Sioux City or Des Moines?

Call 712-212-5482 (Sioux City) or 515-707-9195 (Des Moines, Chaplain Jim Brammeier) and a pastor will visit and report back to you as an extension of your ministry.

#### Prison/Jail Ministries

Rev. Glenn Bohmer (Estherville) is the Coordinator of Prison/Jail Ministries in Iowa District West. If you are involved in or aware of an active ministry, we ask that you share that information with Rev. Bohmer ([gbohmer@gmail.com](mailto:gbohmer@gmail.com)). If you are interested in establishing such a ministry please contact him directly for resources that may prove helpful.

#### Iowa Lutheran School Tuition Organization

The Iowa Lutheran School Tuition Organization (ILSTO) reached its goal for 2016. We appreciate the support of the many people who helped raise money for tuition assistance for Lutheran students across the state of Iowa. What a blessing for the students and families in Iowa West and East who will have financial assistance for 2017-2018. Blessings to you all and have a Christ-filled New Year!

Dewey Torkelson, ILSTO Program Manager

#### VBS Best Practices Workshop

This workshop will focus on best practices from VBS volunteers around IDW, focusing on ways to help make your planning, decorating, teaching, communicating and leading extraordinary and intentionally focused on Jesus! Gain new ideas, network with others, and be inspired as you plan for VBS at your congregation.

When: Saturday, February 11, 9-12:30 a.m.

Where: St. Paul Lutheran Church, 1100 SE Sharon Drive, Ankeny, Iowa

Cost: Free and lunch is included

To register, contact Sue Light ([sue.light@idw/lcms.org](mailto:sue.light@idw/lcms.org) or 515-576-7666) at the District office by February 6, 2017. Please include your church name, city, and the names of the people who will attend the workshop.

#### Churches Planting Churches Workshop

Churches Planting Churches is designed to empower your congregation to give birth to daughter and/or multi-site churches and/or new ministries with biblically missional and organizational integrity. This two-day seminar (February 11-12) includes process time for teams to develop initial plans for multiplication. Register online at [www.iowamissions.org](http://www.iowamissions.org).



#### Calendar of Events

February 11... VBS Best Practices Workshop, St. Paul, Ankeny  
February 11-12... Churches Planting Churches Workshop, SOTV, WDM  
February 17... The Richard G. Kapfer Memorial Symposium, St. Paul, FD

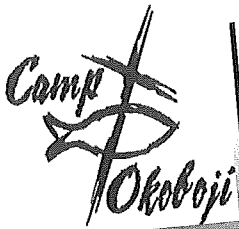

February 2017 (Please Copy, Post, and Share)

# Camp Okoboji News

What is Happening at Your Camp

1531 Edgewood Dr  
Milford, IA 51351  
712-337-3325

**Our Promise of Jesus at the Lake**  
A friendly, safe, refreshing and relaxing Christian experience  
An exceptional value for you and your family

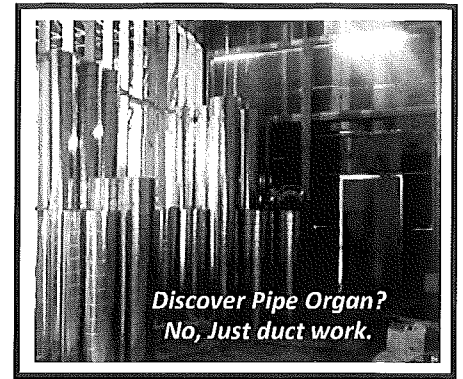

**Camp Okoboji 2017**

Consequently, you are no longer foreigners and fellow citizens people and

aliens, but with God's members of

God's household, built on the foundation of the apostles and prophets, with Christ Jesus himself as the chief corner stone. In Him the whole building is joined together and rises to become a holy temple in the Lord. And in Him, you too are being built together to become a dwelling in which God lives by His Spirit.

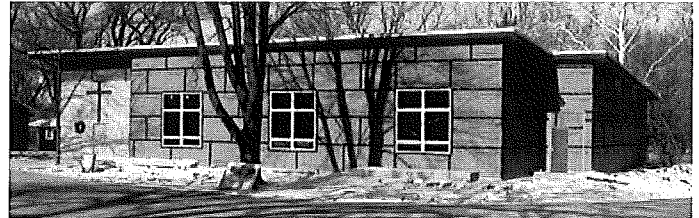

**Under Construction**  
**2017 Programs and Events**

- Feb. 24-25: Junior High C.H.A.O.S. Retreat
- April 22: Annual Meeting & Basket Auction
- April 27-29: Wittenberg Home School Retreat
- May 5-7: Spring Clean-up Weekend
- May 12-14: Youth Volunteer Weekend
- May 21-24: Pastors Continuing Education
- May 26-29: Veteran's Family Retreat
- June 2-4: Kids Kamp
- June 8-11: JOY Camp 1 (Special Needs)
- June 11-14: Adventure Camp
- June 11-17: Girls Sports Camp
- June 18-23: Technology Camp
- June 24: Quilt Auction
- June 24: Paul's Bike-A-Thon Challenge
- June 25-July 1: Minneboji Youth Camp
- July 2-8: July 4th Family Retreat
- July 9-15: Junior High Week
- July 13-16: JOY Camp 2 (Special Needs)
- July 16-22: Concordia Cub Week Youth Camp
- July 23-29: High School Youth Week
- July 30-Aug. 5: Family Retreat I Week
- Aug. 6-12: Family Retreat II Week
- Aug. 11-13: Hispanic Family Retreat
- Aug. 20: Golf Outing
- Aug. 25-27: Adult Retreat
- Sept. 2: BBQ Cook Off Event
- Sept. 20-22: Outdoor Education
- Sept. 28-Oct. 1: Fall Clean-up Weekend & Volunteer Appreciation Dinner
- Oct. 6-8: Fall Women's Retreat
- Sunday Morning Worship: Memorial Day-Labor Day Weekends
- Omelet Brunches: 1st Sundays (May-Nov.)

**DISCOVER CAMPAIGN**  
**Okoboji Update**

**Campaign Reaches \$1,400,000**  
**Phase One Goal! Praise God!**

**THANK YOU!** To all the  
**THANK YOU!** Individuals  
**THANK YOU!** Congregations  
**THANK YOU!** Organizations  
**THANK YOU!** Special Groups  
**THANK YOU!** Helpers &  
**THANK YOU!** Volunteers

**So What Happens Next?**  
The Camp Board is taking time this spring to conduct a Missional Clarity Evaluation with LCEF. This process will help better prepare Camp for the next campaign phase and the over-all future mission of Camp Okoboji.

In the mean time, construction continues, and fund raising will continue as well. Keep looking for updates!

**- Still on the Table -**  
**\$250,000 Matching Gift Challenge:**  
**We're within \$50,000 of meeting this**  
**Challenge! Your Support is Appreciated**  
**and Your Gift Will Still Be Matched!**

## In the Spotlight

**Improved Camp Website and On-line Registration**

**Feb. 24-25: C.H.A.O.S. Jr. High Retreat**  
Get your group together for this amazingly fun winter retreat.

**\* New for 2017 \*  
Technology Camp:  
June 18-23**  
Create and build your own video game!

**Camp Currency!**  
St. Paul, Ames created and gave Camp Currency to their summer campers to spend in the Camp Store. A great encouragement and reward! Contact the Camp office for more information.

- YOUR Participation & Support Needed!**  
We ask our Camp Friends To . . .
1. Pray for the success of Camp Okoboji.
  2. Attend Camp programs and events.
  3. Support Camp verbally and financially.
  4. Share Camp with others and invite them.

**For More Info.**  
**Flyers & Schedules**  
[www.campokoboji.org](http://www.campokoboji.org)

**THRIVENT FINANCIAL**  
Members can make a huge Camp impact with Action Teams and Choice Dollar Designations  
**Don't Forget: Designations must be made by March 31**

**Camp Staff Contact Information**  
Executive Director: Doug Kading [doug@campokoboji.org](mailto:doug@campokoboji.org)  
Office Director: Kellie Jones [kellie@campokoboji.org](mailto:kellie@campokoboji.org)  
Program Director: Lori Gamble [lori@campokoboji.org](mailto:lori@campokoboji.org)  
Min. Advance. Dir.: Paul Golke [paul@campokoboji.org](mailto:paul@campokoboji.org)

# Celebrate Jesus

Celebrate Jesus! In true Lutheran fashion, we ask, “What does this mean?” Does this mean that we are sharing the excitement of the love and grace that God has shown us? For thirty-five IOWAY Petal Pushers the answer was, “Yes, and much more!”

On the back of the bright red sweatshirts that we wore for seven days, we were a billboard to everyone who saw our backs. What an interesting reality! As we walked past people in the airport, at restaurants, at the hotel, while we decorated floats, on Skid Row and everywhere we went for seven days they saw “Celebrate Jesus” on the back of our shirts. They saw it as we walked past them on our way to our next adventure. One sweatshirt may make an impact, but when thirty-five matching shirts, worn by smiling Christians, go together through the airport, a statement is definitely made. We were asked by many people what we were doing and we had an opportunity to share that we were on a mission trip to share Jesus.



The IOWAY group headed out from the Kansas City airport loaded with extra suitcases of items to be distributed to the homeless on Skid Row. We were joined by our Indiana team at the hotel. The adventure started on December 29 and we returned on January 5. Those days were packed with two very full days at the Rose Palace decorating the Lutheran Hour float and others for the famous Rose Parade and one day enjoying the finished floats at Rosemont. Some evenings were spent sorting, counting and organizing the many thousands of items that we distributed at Skid Row. One morning was spent at the 99 Cent Store spending \$2,400 on items for the homeless. This money was lovingly given by individuals and church groups, some was given using Thrivent cards. We also drop shipped Bibles, 1,000 tote bags, hundreds of washcloths, deodorant and 1,000 pairs of athletic socks directly to the Union Rescue Mission building on Skid Row.

Instead of renting eight vehicles as in the past, this year I reserved three shuttles that took us everywhere and we “left the driving to them.” It worked great. The drivers were amazing. At one point, our driver was asked who he was a driver for in the fancy shuttles. He gave them an attitude and replied, “Some very wealthy, older women from Iowa.” We gave him a bad time for the next three days for his “older women” comment.



When the three impressive black shuttles pulled up to where we would normally get out and walk to Colorado Boulevard to view the famous parade, a gentleman assumed we were important so he moved a barricade and we parked half a block from our seats and the drivers parked for free. That was fun. It was also fun for the drivers as they sat with us as two of them had never seen the parade in person before.

Each year for the past fifteen years that I have led this mission event, I am blessed to see how God takes the team of strangers that He has chosen and bonds them together in such a short time to be His 'hands and feet' in such a unique situation.



The Lutheran float was absolutely beautiful! It celebrated the 500<sup>th</sup> anniversary of the Reformation and the nailing of the 95 thesis on that famous Wittenberg Castle door. It also honored the 100<sup>th</sup> anniversary of Lutheran Laymen's League. Pastor Greg Seltz, LHM speaker, and his wife, Yvette rode on the float. I had fun working with Yvette as we ran rice through a kitchen blender to make just the right consistency for use on the float. As you probably know, every inch of the float has to be covered by materials that are or were alive. It's interesting to see all the different types of materials that they use to decorate the only Christian float in the parade. We used to say we were the only religious float but that is no longer true. We are now the only Christian float.

Brenda Bruggeman shared, "I have grown up watching the parade on TV each year. It started with my dad waking us with, 'The parade is on!' When I heard about this opportunity to actually help with the parade, I jumped at the chance. It definitely hits a bucket list item to sit with my feet on Colorado Blvd. and see the parade in person. It will always be more meaningful since I know all that goes into the construction of the floats. Each part of that process from the assembly of the floats, meeting other people working on the floats, and watching the final product was beyond my expectations. I loved being on the scaffolding. Perhaps the mountaintop experience for me was meeting these incredible people of God. We have shared laughter, tears, prayers and abundant joy. We have served together and become knit together in heart and friendships. I will miss these sweet, bubbly, wise, caring and energetic people."

Connie Mekus shared, "I had looked forward to my first time as a Petal Pusher all year. I wasn't disappointed. It has been a wonderful experience. From meeting everyone for the first time to walking into the Rose Palace for the first time and all of us working together, supporting each other and sharing our faith. It is heartwarming to hear how well-respected the Petal Pushers are and how God has shown us a way to serve Him. It was truly an honor to have worked on the Lutheran Hour float."

Gayle McGilvrey reflected on the Skid Row experience, "Makes me appreciate my life much more. I'm glad these people have someone to help them. They were friendly and said 'thank you' for what we gave them. The kitchen people appreciated the help from us. It is sad to see the tent homes along the streets. It was a good day."

Sam Lee recalled, "It made me cry. I have never seen anything like this before. The people were so kind when they came up for their lunch. I was fortunate to be able to hand their food to them. We live in America and to see the streets lined with boxes, chairs and blankets on the sidewalk for their bed – oh, so sad! We are all God's children and I know He will provide."

A team member shared, "My favorite part of any trip is always the people. I am thankful for time with friends from the past and opportunities to make new ones. I feel blessed by the honest stories shared during shuttle rides, over meals and especially during work on the floats. My great thanks to Ellie and Lynn for the hours of 'behind the scenes' work that makes every event flow flawlessly."

Another team member expressed their thoughts by writing this prayer, "Heavenly Father, thank You for the opportunities to serve today. I am overwhelmed by the undeserved blessings You have showered on me and my family. I ask for your protection and healing to be poured out on the Union Rescue Mission. Let Your Holy Spirit take over this place. Give an extra measure of peace, godly wisdom and faith to grow in this place. From the ashes of Skid Row, rise up a powerful group of men and women who strive for You with all their hearts. Grant them a redemption story that brings You glory and makes people around them take notice. Show me how You want me to serve. In Jesus' name. Amen."

For photos and six daily trip updates, please check out [www.servinggodbyservingothers.blogspot.com](http://www.servinggodbyservingothers.blogspot.com). Any questions on how to get involved with mission trips or service outreaches, please contact me:

Ellie Menz, IOWAY Director  
[ellie.menz@idwlcms.org](mailto:ellie.menz@idwlcms.org) | 515-370-1159

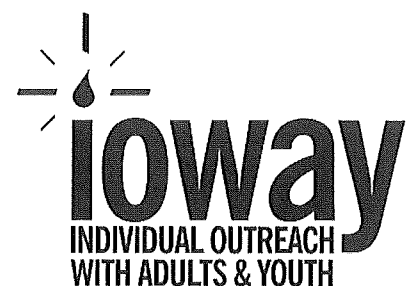

# FEBRUARY 2017

SUNDAY	MONDAY	TUESDAY	WEDNESDAY	THURSDAY	FRIDAY	SATURDAY
			<b>1</b> 9:30 Bible Study 4:00 Midweek 6:30 Evening Cir	<b>2</b> 4:00 Youth make Subs	<b>3</b>	<b>4</b> <b>NO WORSHIP</b>
<b>5</b> 9:00 Chr. Ed 10:00 DW/HC	<b>6</b>	<b>7</b>	<b>8</b> 9:30 Bible Study 2:00 Midweek	<b>9</b>	<b>10</b>	<b>11</b>
<b>12</b> 9:00 Chr. Ed 10:00 DW 11:00 Church Council Meeting	<b>13</b>	<b>14</b>	<b>15</b> 9:30 Bible Study 4:00 Midweek	<b>16</b>	<b>17</b>	<b>18</b>
<b>19</b> 9:00 Chr. Ed 10:00 DW/HC	<b>20</b>	<b>21</b>	<b>22</b> 9:30 Bible Study 2:00 Midweek	<b>23</b>	<b>24</b>	<b>25</b>
<b>26</b> 9:00 Chr. Ed 10:00 DW	<b>27</b>	<b>28</b>				

**USHERS**

Dwight Ehlers      Randy Neumann  
 Brian Kraus        Jake Kraus  
 Curtis Ehlers       Dale Lenz  
 Brad Hinners       Zack Kraus  
 Colton Neumann    Ryan Neumann

**Parish Circle**

Paulette Von Glan  
 Marilyn Mueggenberg  
**Chancel Circle**  
 Paulette Von Glan  
 Marilyn Mueggenberg

**Acolytes**

**5<sup>th</sup>:** Hunter Klink & Elizabeth Brunner  
**12<sup>th</sup>:** Hannah Kraus & Timothy Dose  
**19<sup>th</sup>:** Riley Neumann & Jamie Hausman

**MIDWEEK SERVERS**

1<sup>st</sup>    Steph Hinners  
 8<sup>th</sup>    Tammi Brunner (2 pm)  
 15<sup>th</sup>    Denise Ragaller  
 22<sup>nd</sup>    ????

**REMINDER**

**NO SATURDAY SERVICE ON THE 4<sup>th</sup>**



Zion Lutheran Church  
118 W Tracy St  
Box 59  
Arcadia, IA 51430  
Rev Ben Dose  
712-689-2441

Non-Profit Organization  
Arcadia, IA 51430  
Standard Mail

*Friends Who Care*

*Christian Education 9:00 am*  
*Divine Worship 10:00 am*

# *Friendship Sunday*



# *February 12, 2017*