

“Dose of Wisdom”

Can you believe it? It's that time again. We are gearing up here for Ash Wednesday and the season of Lent. Time seems to move faster and faster each year. This year for the season of Lent we are looking at “Returning from Exile”. This is what we are looking at this Lenten season.



Once again we prepare to enter into the Lenten season as we journey through the Church Year. Lent, however, is its own kind of journey. Lent is the journey we make as we travel with Christ from the Mount of Transfiguration to Jerusalem where He will face the cross and the grave for our sakes. It is a very sobering trip, a journey that often struggles to find joy. But there is Easter!

This year our theme for our Lenten worship will focus upon the journey, but perhaps not in the way we usually walk it. Our overall theme will be “Return from Exile: A Lenten Journey.” All journeys must have a starting point; and in the preaching and teaching this Lenten season, we will consider our starting point a land of exile.

The land of exile from which we begin our journey is the wilderness of sin and death. Sin came into the world when our first parents were unfaithful and disobedient, eating fruit from the tree of the knowledge of good and evil. Adam and Eve sinned, and we have inherited from them not only the sin itself, but also the result of that sin—separation from our Lord and God. From the first sin in the first garden, we have been exiled into the wilderness where we have wandered without any ability to find our way out.

This is the beginning of our journey: exile. But every journey also has a destination, an ending point. Our return from exile brings us into the promised land. Our relationship with our God is restored by Christ's sacrifice. Our destination, then, is the perfect place, the new garden, the courts of heaven—the ultimate destination which was established for us by His death and resurrection. There is great joy in the journey as we see where our returning brings us; but there is also a somber attitude when we consider what Christ faced on account of our sin.

All journeys consist of many events that take place between the journey's beginning and its end. Our Lenten journey is no different. Each leg of our Lenten journey begins in the Old Testament and then continues into the New Testament, pointing us to the joy that is ours in

Christ Jesus. Do not be surprised to discover that from the very beginning, even outside the gates of the Garden of Eden, it is Christ who travels with us. He has always been our guide, from the very beginning, and He will journey with us to the very end. Indeed, He has even gone before us to prepare a heavenly dwelling place.

Life is full of journeys. Life itself is a journey. We enter this Lenten season contemplating the reality of our earthly journey but with eyes fixed on its destination—the empty tomb and the open gates of everlasting life. What joy there is in knowing that we do not walk this way alone!

Blessings in Christ,

Pastor Dose



Please be sure to join us on Wednesday, February 14th for Ash Wednesday, as we begin our Lenten Journey. Services will be held at 11 am and at 6:30 pm each Wednesday evening until March 21st. A lunch will be served at noon.



Feb 14	11:00 & 6:30	Ash Wednesday/ Holy Communion
Feb 21	11:00 & 6:30	Midweek Service
Feb 28	11:00 & 6:30	Midweek Service
Mar 07	11:00 & 6:30	Midweek Service
Mar 14	11:00 & 6:30	Midweek Service
Mar 21	11:00 & 6:30	Midweek Service
Mar 25	10:00	Palm Sunday/ Confirmation
Mar 29	11:00 & 6:30	Maunday Thursday/HC
Mar 30	11:00 & 6:30	Good Friday
Mar 31	6:30	Easter Vigil
April 01	8:00	Easter Service/HC



LENTEN MEALS

A lunch will be served following the 11 am Midweek Lenten Services.

L.Y.F. NOTES



Sub Sandwich Sales

They LYF has been taking Sub Sandwich orders for Super bowl Sunday. They will be making the sandwiches on Wednesday, January 31st at 4 pm.. The sandwiches will be available for pick up or delivery. There will be some additional sandwiches made for those who did not place an order or who wish to purchase additional sandwiches. Remember they are great frozen for later use in addition to being served for Super bowl Sunday. Sandwiches are made with Roast Beef, Ham, turkey and 2 types of cheese, They are selling for \$3.50 each or 5 for \$15 Thank you for your support. It is appreciated.



Winter has settled into the Sunday School. Even though it is cold outside we have a lot of warm hearts inside due to the Good News of Jesus Christ being shared by our teachers and students.

February is Friendship Sunday month! We are working on a new song we will be presenting on February 11th along with observing Friendship Sunday Bring a friend. The more the merrier.

Thank-you to everyone that helped with the Christmas Program, The children did an awesome job! We were worried some days but the kids and staff pulled it all together. Special thanks to the parents for making sure the kids were there

FRIENDS ARE

**TRUTHFUL
CARING
RELIABLE
HELPFUL
POLITE
INTERESTING
ALWAYS THERE
FOR YOU.**

Joy

**SHARE JESUS
WITH A FRIEND**



Friendship Sunday --- February 11, 2018

WE WANT YOU TO INVITE SOMEONE!

Invite a Friend to Church

You may not have done this before – but this year we want you to! Consider a neighbor, a friend, a relative, someone with whom you work, or see occasionally. They could be new to the area or someone who has been around for years. God wants you to invite them. The front entry of our church with its stain glass windows were designed to make people look, wonder, and want to come in – but the doors alone cannot do this. **WE'D LIKE YOU TO TAKE THE FIRST STEP**; the Holy Spirit will help. Offer to pick them up if there is any way you could work this out.

Come, join us and bring a friend or two! You'll learn some things which may surprise you and all those who come will not go away hungry.

FRIENDSHIP ABLAZE! MEANS BUILDING FRIENDSHIPS: Perhaps there is an acquaintance in your life who needs you to build a stronger friendship with him/her. Maybe it is your mechanic, your hair dresser, a neighbor, or a person at work. You are someone who can share the greatest Friend any of us will ever have. Now is the time to intentionally build that friendship. Spend time with that person. Remember birthdays, anniversaries. Share your times of joy and celebration with that person. Seek ways to help and encourage your friendship. This is how we set our friendships *Ablaze!*



We would like to offer our Christian sympathies to the family of Gladys Noelck. Our sister in faith was called home on January 13th and her mortal remains were committed to await the Day of Resurrection on January 19th.



Work Hard,
Do Your Best,
Keep Your Word,
Never Get Too Big For Your Britches,
Trust In God
And Never Forget a Friend

LUTHERAN

WITNESS

If you would like to renew or become a new subscriber to the Lutheran Witness, please contact the church office by Sunday, February 25th. The cost is \$22.67 for a year.

Refocus for Lent

Give up complaining — focus on gratitude.
Give up harsh judgments — think kind thoughts.
Give up worry — trust God to provide.
Give up discouragement — be full of hope.
Give up bitterness — turn to forgiveness.
Give up hatred — return good for evil.
Give up anger — be more patient.
Give up pettiness — become mature.
Give up jealousy — pray for trust.
Give up gossiping — control your tongue.
Give up sin — turn to virtue.
Give up giving up — persevere.

—Author unknown

Mealtime as a family

Amid busy and varied schedules, many families find a way to sit down together for dinner regularly. Family-health advocates describe the benefits: an increased sense of unity, children sharing news and feeling listened to, and the physical perks of a planned, seated meal.

In Scripture, many great encounters between people and God happen around meals. Abraham and Sarah prepare a meal for three guests who turn out to be angels (Genesis 18). God instructs the Hebrew slaves to eat a special meal together before their delivery from Egypt (Exodus 12); every year since, Jews have celebrated the Passover feast. Elijah is strengthened with food served by an angel (1 Kings 19). Jesus shares meals not only with religious leaders but with “sinners” (e.g., Matthew 9). Jesus’ Last Supper with his disciples before his death has become one of the church’s sacraments and a “foretaste” of the heavenly banquet to come.

When Christian families eat together, it’s a holy time in God’s presence, just as when the church shares Holy Communion — a true fellowship dinner!

“Teach us to love”

O God, perfect us in love,
That we may conquer all selfishness and hatred of others;
Fill our hearts with thy joy,
And shed abroad in them thy peace which passeth understanding;
That so those murmurings and disputings
To which we are too prone may be overcome.
Make us long-suffering and gentle,
And thus subdue our hastiness and angry tempers,
And grant that we may bring forth the blessed fruits of the Spirit,
To thy praise and glory, through Jesus Christ our Lord. Amen.

—Rev. Henry Alford (1810-1871)

February Birthdays & Anniversaries

SUNDAY	MONDAY	TUESDAY	WEDNESDAY	THURSDAY	FRIDAY	SATURDAY
				1 <i>Carnille Mumm</i>	2	3 <i>Spencer Owen Denise Ragaller Kendyl Riesberg Grant Wilken</i>
4 <i>Olivia Mau</i>	5 <i>Cassie Neumann Paulette Von Glan</i>	6	7 <i>Hannah Kraus</i>	8 <i>Dylan Vetter</i>	9 <i>Donna Schurke</i>	10 <i>Dane Dirks Mary Lou Kraus</i>
11 <i>Denny Maasen Marilyn Mumm</i>	12	13	14 <i>Shayna Himmers Trama Vetter Jacob Wittrock</i>	15	16 <i>Ryan Middleton</i>	17 <i>Brandon Himmers Lacey Middleton</i>
18 <i>Wyatt Ragaller</i>	19 <i>Tyler Middleton</i>	20	21	22 <i>Brian Hausman</i>	23	24 <i>Janice Wilken</i>
25 <i>Doug Kuhl Raelyn Petersen Gavin Thiedeman</i>	26	27	28 <i>Wilbert Ehlers Emily Weller</i>			

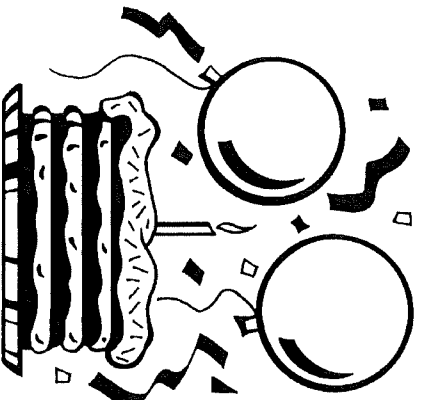

Birthdays &
Anniversaries
This Month!

The Love of JESUS

Three coins in a fountain! I can hear those words in my head from a song long ago. It simply came to mind as I was beginning this article with three photos on a page. Are you wondering about these three unrelated photos? How could people covered with beautiful quilts, a group of blue sweat-shirted people against the Los Angeles skyline, and the Lutheran Hour float in the Rose Parade on January 1 have any connection? Surely they must have a common thread to be featured in this article.

Petal Pushers in Pasadena at the famous Rose Parade know the answer. Twenty-nine people, most from the western half of Iowa, traveled to sunny California to decorate the only Christian float in the parade. As IOWAY Director, I led the trip for the 15th time. The group worked two eight-hour shifts decorating floats.



The first shift started in the flower area where thousands of yellow roses were put into vials. Later, the work shifted to decorating floats in a huge building that was a few miles from Pasadena. The second shift, on day two, found nearly half of the group excitedly working on the Lutheran Hour Float. They attached much of the greenery and most of the roses onto the sides of the beautiful float! The float was a witness to millions of people, showing the love of Jesus along Colorado Boulevard and on TV on New Year's Day.

The next day, the group worked at the Union Rescue Mission in downtown Los Angeles, showing the love of Jesus to the homeless on Skid Row. They shared approximately 1,000 health kits and thousands of dollars of other supplies donated by people from Iowa. This action demonstrated the love of Jesus to those struggling in Los Angeles. The homeless very much appreciated this outpouring of love. The group gathered on the roof of the building for a photo against the Los Angeles skyline as the day ended. The love of Jesus had affected the group members as much as it had the homeless.



That evening, Kimberley, a teacher in one of the poorest districts in the Los Angeles school system, came to share about the life of her classroom children. On a trip a few years ago, Karen from Lone Rock, Iowa, was moved to show the love of Jesus to Kimberley's kids. Karen loves to make quilts so she began making quilt tops. LWML ladies across Iowa District West volunteered to tie them. This year's team brought 38 of those quilts to California. It was the love of Jesus that motivated Karen to make them, motivated the ladies to tie them, and overwhelmed Kimberley as the team covered her with evidence of that love by spreading the quilts over her.



She passes on the love of Jesus to each of her students as they receive a quilt. Those quilts bring the love of Jesus down into the laps and lives of those sixth graders. It is a special gift they will never forget for it is totally unique, something in their lives they never dreamed of. Jesus is like that, His love is beyond what we can dream or imagine.

Three photos on a page! Yes, they do fit together. All three were composed and lighted by the love of Jesus in the lives of His people. Thanks be to God!

For daily trip updates and photos of the Pasadena trip, go to <http://servinggodbyservingothers.blogspot.com>

Ellie Menz, IOWAY Director
807 West South Street, Jefferson, IA 50129
515-370-1159 | ellie@iowadistrictwest.org

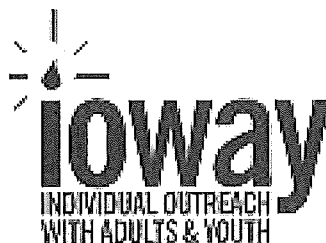



February 2018 (Please Copy, Post, and Share)

Camp Okoboji News

What is Happening at Your Camp



For More Info. / Fliers / Schedules
And to Register Online
www.campokoboji.org

1531 Edgewood Dr
Milford, IA 51351
712-337-3325

Our Promise of Jesus at the Lake
A friendly, safe, refreshing and relaxing Christian experience
An exceptional value for you and your family



Warmth in the Cold

The holidays brought many families to Camp for celebrations, reunions, and fellowship. They settled into comfy couches and reflected on the year. They got caught up with family not seen for some time. They played games and had fun. They enjoyed food and snacks. *And* they created new and lasting memories.

When visiting with these families and groups, their warmth radiates from their faces and their gratitude is truly heartfelt.

How blessed we are to have such a wonderful place to gather.

The holidays also brought some of the coldest temperatures recorded. One morning, with the temp at -9 degrees, a triple sun dog framed the Refuge Chapel and nativity.

The warmth of Christmas (Christ coming to us) even radiates in the cold. Beautiful!

Camp Okoboji is an amazing gathering site for many groups and activities. It offers a truly unique and charming location.

**How Can Camp Okoboji Help You?
Let's Discover Together**

In the Spotlight

Feb. 10: Make It Take It
9:30-11:00am
Creative Spirits Event
Come for this fun morning.
Create this "Love" painting.
Please RSVP 712-337-3325



Feb. 23-24: C.H.A.O.S.
Jr. High Retreat (Gr. 6-8)
Get your church youth together for this amazingly fun winter retreat.

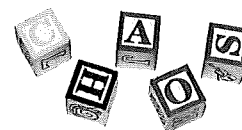

Cost: \$75 per person
Bible study leader: DCE Tim Kightlinger
Gloria Dei Lutheran, Urbandale
Music leader: Russell Baumann, St. Paul, Carroll

March 10: Make It Take It
9:30-11:00am
Craft Extravaganza!
Check the Website for information.



Mark Your Calendar!
May 17-20
Spring Men's Retreat
Enjoy the great outdoors with fishing, archery, golf and shooting ranges (indoor and outdoor)! Check the website for more information.



Summer Employment Opportunities:



Program Staff for on-site Day Camp Programs, Week-long Youth Camps, and leading Vacation Bible School in churches and communities.

Also Needed: Lifeguards, Store Clerks, Food Service and Housekeeping personnel.

For Additional Information Contact the Camp Office at 712-337-3325 or go to www.campokoboji.org
Get Ready For An Amazing Summer!

College Students: Please access the National Lutheran Outdoor Ministry Association (NLOMA) website at www.nloma.org to download and fill out an application.

High School Youth: Contact Camp Okoboji and request an application form. Minimum age requirement: 16

Camp Staff Contact Information

Executive Director: Doug Kading doug@campokoboji.org
Office Director: Kellie Jones kellie@campokoboji.org
Program Director: Lori Gamble lori@campokoboji.org
Min. Advance. Dir.: Paul Golke paul@campokoboji.org
Bookkeeper: Karrie Mullenberg karrie@campokoboji.org

**Promotional Materials Coming Soon for
2018 Camp Programs and Events!
Look For Them!
Check Out The Camp Website!
Make Plans Now!**



“Now faith is the assurance of things hoped
for, the conviction of things not seen.”

Hebrews 11:1

Summer 2018 Program Offerings

Summer 2018 Chaplain Schedule

- January 26-28 Family Ice Fishing Retreat
- 27 Winter Games & Ping Pong Tournament
- February 23-24 C.H.A.O.S. Jr High Retreat
- April 7 Annual Mtg/Basket Auction
- 20-22 Spring Women’s Retreat
- May 3-5 Spring Volunteer Weekend
- 11-12 Youth Volunteer Weekend
- 7-20 Spring Men’s Retreat
- 25-28 Veterans’ Retreat
- June 1-3 Kids’ Kamp
- 7-10 JOY Camp I (Special Needs)
- 10-15 Technology Camp
- 10-16 Girls’ Sports Camp
- 17-23 Minneboji Youth Camp
- 23 Paul’s Bike-a-thon Challenge Ride
- 24-26 IDW District Convention
- 28-30 LWML District Convention
- July 1-6 July 4th Family Retreat
- 7 Auxiliary Annual Quilt Auction
- 8-14 Jr High Week
- 12-15 JOY Camp II (Special Needs)
- 15-21 Concordia Cub Week
- 22-28 Youth Week
- 29-August 3 Family Retreat I
- August 5-10 Family Retreat II
- 10-12 Hispanic Family Retreat
- 19 Golf Outing
- 24-26 Adult Retreat
- September 19-21 IDW Lutheran Schools Outdoor Education
- 27-30 Fall Volunteer Weekend
- 29 Volunteer Appreciation Dinner
- October 5-7 Fall Women’s Retreat

Worship at 9:45am, Coffee & Rolls to follow

- May 27 The Rev Michael Moreno
Norfolk, NE
- June 3 The Rev Benjamin Dose
Zion, Arcadia, IA
- June 10 The Rev David Dahlke
Shepherd of the Valley
West Des Moines, IA
- June 17 TBA
- June 24 The Rev. David Otten
Emmanuel, Gettysburg, SD
- July 1 TBA
- July 8 The Rev Jonathan Riggert
Trinity, Cherokee, IA
- July 15 The Rev David Dahlke
Shepherd of the Valley
West Des Moines, IA
- July 22 The Rev Steve Hayden
Mt. Calvary, Indianola, IA
- July 29 The Rev Kyle McBee
Zion, Humboldt, IA
- Aug. 5 The Rev Wallace Schulz
Augusta, MO
- Aug. 12 The Rev Timothy Fitzner
Christ Lutheran, Normal, IL
- Aug. 19 TBA
- Aug. 25 The Rev Greg Finke
League City, TX
- Sept. 2 The Rev Robert Schaedel, EM
Palmyra, NE

Omelet Brunches:

First Sundays of the month: May-November



THE LUTHERAN CHURCH-MISSOURI SYNOD

Planting Together

February 2018

409 Kenyon Road, Suite B — Fort Dodge, Iowa 50501
515-576-7666 Fax 515-576-2323 www.idwlcms.org
Contact email: sue@iowadistrictwest.org

On a Mission to Support Christ's Mission!

Encourage One Another

Brothers and sisters in Christ, let's encourage each other. "Therefore encourage one another and build each other up, just as in fact you are doing" (1 Thessalonians 5:11). Most people when they think of February have some thoughts about Valentine's Day — a day where cards, candy and flowers may be given to someone they love. In addition to that practice, I propose we spend time thinking about who we could encourage this month and in the months to come.



Encouragement is defined as "the action of giving someone support, confidence, or hope." I thank God that He has used people to encourage me in my faith — parents, pastors, Sunday school teachers, youth counselors, camp counselors, and friends. God knows we need encouragement and so He has given us each other and He has given us His Word. Did you realize the word "encourage" can be found in the New Testament over 100 times? In Hebrews 3:13 we read, "But encourage one another daily, as long as it is called 'Today,' so that none of you may be hardened by sin's deceitfulness." Who will you encourage today? May God give us all the grace to *DAILY* encourage people.

Dear God, forgive me when I'm quick to criticize instead of encourage. Help me to see opportunities to encourage others in a way that helps them to grow. In Jesus' name. Amen.

Rhonda Mohr, Assistant to the President
515-573-0010 | rhonda@iowadistrictwest.org

Church Worker Scholarships

Iowa District West offers substantial scholarships to those students who are going in to full time church work or those attending one of our Concordia Universities. Applications for the 2018-2019 scholarship are located on our Iowa District West website under the tab resources and forms and links. Applications are due by June 1. Rev. Tom Schlund, Senior Pastor at Trinity, Algona, is our new Director of Student Financial Aid. We thank Rev. David Loeschen for his many years of faithful service as Director.

Strengthening Your Marriage Workshops

It's a new year! Don't miss out on an opportunity to spend some time strengthening your marriage. You may choose one of two locations each led by a Lutheran Family Service Marriage Counselor: February 3, at Zion Lutheran, Manning led by Lynette Aschinger or February 10 at Redeemer Lutheran, Sioux City led by Karen Gotto. Workshops start at 9am and will conclude at 2pm. Cost is \$40 per couple which includes morning refreshments and lunch. If you have childcare needs indicate this on your registration. Register at this link: https://www.surveymonkey.com/r/Strengthening_Marriages_Workshop

Creation Theater at Mission Central

Mission Central is now ready to receive tour groups to see the Lord's Creation Theater where they will hear the REAL STORY of how our God made the world in 6 days! Due to the number of people coming to Mission Central, it's important to contact them for available tour times. Come and see what the Lord has done at this place in the middle of nowhere as it will "blow your socks off" and will truly be a "once in a lifetime experience." Contact Mission Central at 712-882-1029 or email Gary at Gary.Thies@lcms.org.

Joy in Ministry Banquet

Mark your calendar for June 3, 5:30-8:30pm for our 2018 Joy in Ministry Banquet. It will take place at the Carrollton Inn in Carroll. Our 2018 Joy in Ministry Banquet desires to have a recruitment focus. Help the district identify students who should be encouraged to consider full time church work and be invited to attend this special event. Pray with us about this event - pray that young people would respond to the Holy Spirit's prompting to work in our churches and schools. More details will be shared in the coming months.

Calendar of Events

February 3...Strengthening Your Marriage Workshop, Manning
February 10...Strengthening Your Marriage Workshop, Sioux City
February 14...Ash Wednesday
February 15...Board of Directors Meeting, District Office

For more information on Iowa District West activities, view *The Messenger* at www.idwlcms.org/publications.php

Camp Okoboji Men's Retreat May 17-20, 2018

Calling all men! Men's Retreat at Camp Okoboji!

Full Package deal—\$160, includes lodging on Thursday; Friday supper and lodging; all meals and lodging on Saturday; Sunday Breakfast; towels, linens, and program fee.

Friday-Sunday Package—\$135, includes all of the above except Thursday lodging.

What to Expect: Options for indoor and outdoor shooting, fishing, archery and golf! Plus campfires, fellowship, and spiritual growth! Hanging out with other men, doing the things that men do! There will also be plenty of time to relax, play lawn games, canoe and other camp activities.

What to Bring (depending on the activities you choose to participate in): Fishing poles/ tackle, pistols or rifles, ammunition, golf clubs, etc. Many of these items can be shared or rented.

For more information and to register online, go to www.campokoboji.org

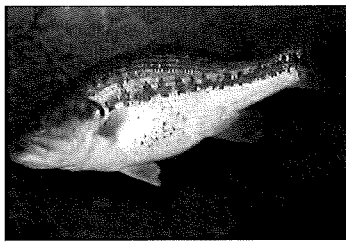
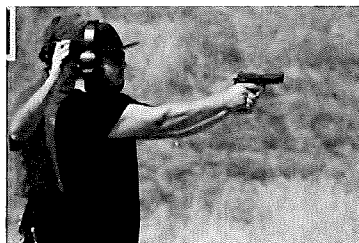

Our Experts for the Weekend!

Luke Timm—Shooting, Ben Dose—Fishing, Marty Eby—Archery



SPECIAL MEMBERS FROM ZION IN DENISON, IOWA VISIT

What a special blessing to welcome Missionary Grandparents Steve and Connie McCollough (members of Zion Lutheran Church in Denison) for a special tour on December 27.

Yes, this grandpa and grandma, who are real missionaries, wanted their children and grandchildren to tour the new Creation Theater and also tour the Barn Museum at Mission Central. We hope and pray that these grandchildren will remember this tour as long as they live.

What a blessing to have this entire family come and hear about how the Lord made all the animals on the sixth day, and also to hear HOW THE WORD BECAME FLESH AND DWELT AMONG US!

Pictured is the family gathered in the little wayside prayer chapel for a final prayer before they left the Lord's Mission Central.



Mission Central – LCMS World Mission

40718 Highway E16
Mapleton, IA 51034
712-882-1029

Gary Thies (gary.thies@lcms.org)
Rev. Brent Smith (brent.smith@lcms.org)
www.missioncentral.us

AMAZING BECK FAMILY CHRISTMAS

Each year after Christmas the amazing Kenneth and Althea Beck Family meets in Columbus, Nebraska. Even though Kenneth and Althea are in our real home in heaven, the family carries on an AMAZING MISSION TRADITION AT CHRISTMAS.

In lieu of gifts, the family gathers and selects a special Missionary to support with their "Christmas Gifts." The family met on December 30 in Columbus and selected Missionary Josh Lange and his dear family in Shanghai China. What a blessing for the Lange Family!

The Beck Family is pictured at their "Family Christmas." Family members came from all over the United States. What a great example for all of us!



SPECIAL NOT NORMAL FAMILIES COME FOR CHRISTMAS

What a blessing to welcome three special families that had their children and grandchildren together for Christmas!

On Friday evening, December 22, the families of Rev. David Loeschen (Denison); Gary and Karen Christiansen (Denison); and Darwin and Sharon Hamann (Anthon) visited Mission Central.

Their families were all together at Christmas with some coming all the way from Washington state! They all came to see and hear the story of how our God made all things **in six days**, and on the sixth day HE made the animals of the world. They were able to see and hear what took place when the world was created.

It was a special time for these NOT NORMAL people who came to see what God is doing at HIS Mission Central. The families are pictured in the new Creation Theater. It was a special evening!



**MISSION CENTRAL EVENTS
PLEASE MARK YOUR CALENDARS!**



Rev. Joe & Jennie Asher
Germany
Saturday, February 17, 2018
1 PM

Carol Halter

Asia

Saturday, February 24, 2018

1 PM

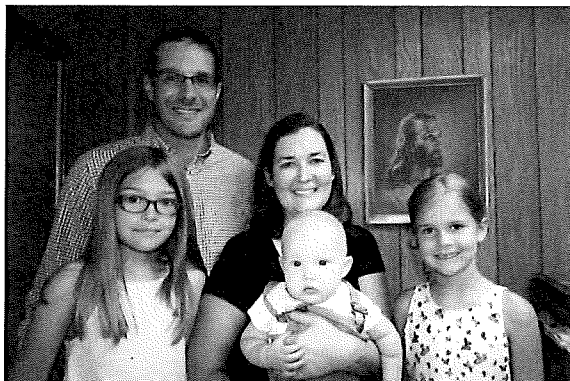

Rev. J. P. Cima & Family

Asia

Saturday, February 24, 2018

1:30 PM

Rev. Eddie Hosch & Family

Peru

Saturday, March 10, 2018

1 PM



Rev. Andrew Schlund & Family

Mexico

Saturday, March 17, 2018

1:30 PM

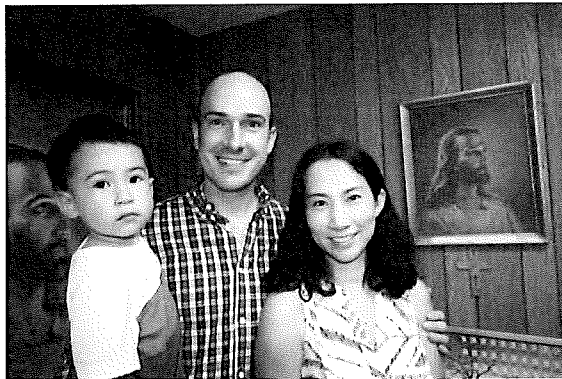
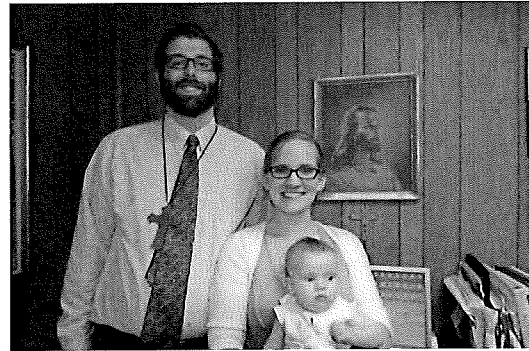

Josh Lange & Family

Asia

Saturday, April 7, 2018

1 PM

Rev. Eddie Hosch & Family

Lima Peru

Saturday, April 21, 2018

1 PM

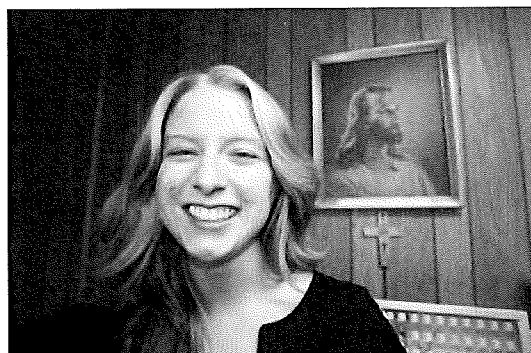

Caitlin Worden

Lima Peru

Saturday, April 21, 2018

1 PM

Rev. Jon Clausing & Family

Kenya East Africa

Saturday, June 2, 2018

1 PM

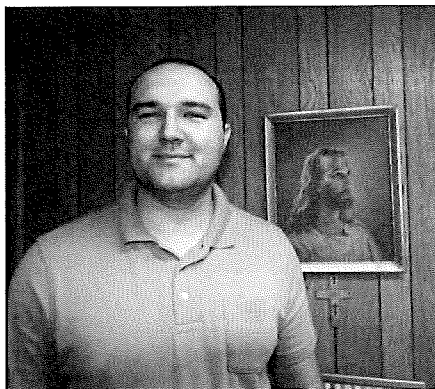
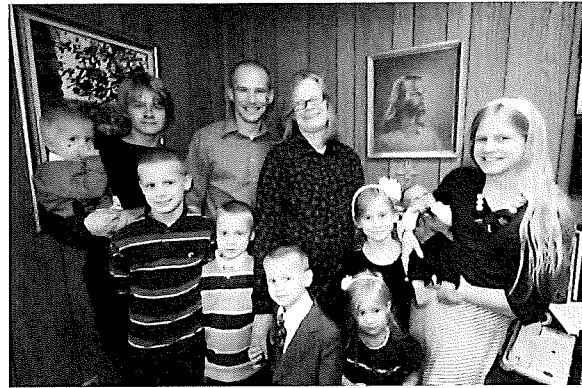

Rev. Jacob Gaugert

Togo West Africa

Saturday, August 11, 2018

1 PM

Mission Central-LCMS World Mission

40718 Highway E 16
Mapleton, Iowa 51034
Phone: 712-882-1029

Gary Thies - gary.thies@lcms.org
Rev. Brent Smith - brent.smith@lcms.org
www.missioncentral.us

JESUS, MY SPECIAL FRIEND

When the troubles of this world crowd my
mind, I turn to Jesus every time

I tell Him all that in my heart
So he can do his work of art
On my thoughts, my fears and doubts
He dries my tears and drives evil out
He has never told a secret yet
An He understands me you can bet

He treats me go gentle and so kind and
Holds me close to Him at times
Sometimes I can almost hear him whis-
per "I love you, please don't cry" He gives
me strength to carry on
When I have thought and cried till dawn
He is the very best kind of friend
On Him I can always depend

He is never to busy to listen to me and
He fills my heavy heart with glee
I hope I can be the kind of friend to Him
as He has always been to me

Kay Harrison



Jesus
Our True Friend



"A friend loves
AT ALL TIMES."

PROVERBS 17:17, NRSV

A Friend in Jesus"

Who could I turn to?
There's no one, but you,
My Savior who loves me,
Guides me each day through.

My Savior, who's there,
When I need a friend,
Always ready and able,
For my problems, to tend.

My Savior, who's there,
When I'm down sick or crying,
Even when my life's path,
Full of knots needs untying.

What could I say?
Your love shines forever,
Burning in my heart,
Lighting any stormy weather.

What back, could I give?
But just words, I love you
And what back might I ask,
Knowing you love me too.

Thank you, my Savior,
You're my real true friend,
You gave your life for me,
And on you I can depend.

ChrisRS ®©1986
"All Rights Reserved"

The Holy Alphabet

(Whoever came up with this one must have had some Divine guidance!)

Although things are not perfect
Because of trial or pain
Continue in thanksgiving
Do not begin to blame
Even when the times are hard
Fierce winds are bound to blow
God is forever able
Hold on to what you know
Imagine life without His love
Joy would cease to be
Keep thanking Him for all the things
Love imparts to thee
Move out of "Camp Complaining"
No weapon that is known
On earth can yield the power
Praise can do alone
Quit looking at the future
Redeem the time at hand
Start every day with worship
To "thank" is a command
Until we see Him coming
Victorious in the sky
We'll run the race with gratitude
Xalting God most high
Yes, there'll be good times and yes some will be bad, but...
Zion waits in glory...where none are ever sad!

"I AM Too blessed to be stressed!" The shortest distance between a problem and a solution is the distance between your knees and the floor.
The one who kneels to the Lord can stand up to anything. Love and peace be with you forever, Amen.

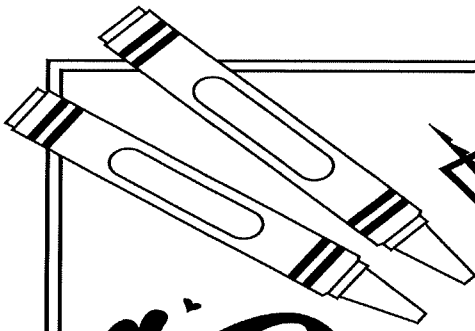

PUZZLE

God's Love

We can't measure God's love for us. It starts before we're born and continues for eternity.

Directions: Down the left-hand column, spell out the name of each number. Then write the circled letters on the blank lines in the right-hand column. Read the words on the right, from top to bottom, to see what Psalm 33:22 (NIV) says about God's love.

20	_____○
4	○○○○
99	○○ - ○○
7	○○
1	○
28	○ - ○ ○
60	○
40	○○
70	○○○○
6	○
12	○ ○
64	○
14	○○○
81	○ - ○ ○
9	○○
24	○ - ○○

“M a _____
 y _____
 u _ f a _ l _ _ _ g
 l o _ _ _
 b _ _
 _ _ _ _ h
 u _ ,
 L _ _ _ d,
 _ _ _ _ _
 a _ _
 _ _ _ _
 p _ _ t
 _ _ _ _
 _ _ _ p _
 _ _ _
 _ _ _ _ .”

PSALM 33:22, NIV

Fourteen..... our
 Eighty-one..... hope
 Nine..... in
 Twenty-four..... you”
 Sixty..... us,
 Forty..... Lord,
 Seventy..... even
 Six..... as
 Twelve..... we
 Sixty-four..... put
 Twenty..... “May
 Four..... your
 Ninety-nine..... unfailing
 Seven..... love
 One..... be
 Twenty-eight..... with

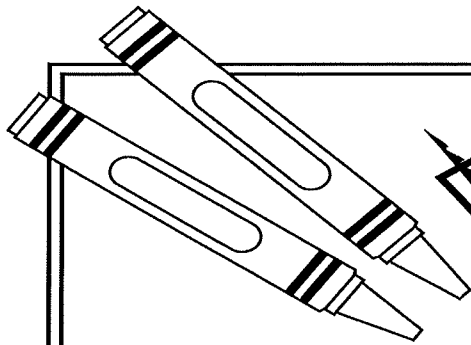

PUZZLE

Conversation hearts

The world encourages people to look out for themselves and seek success, but in Micah 6:8, God tells us to live differently.

Directions: Put the conversation hearts in the correct order by writing the words on the lines below. Hint: Capitalization and quotation marks are included.

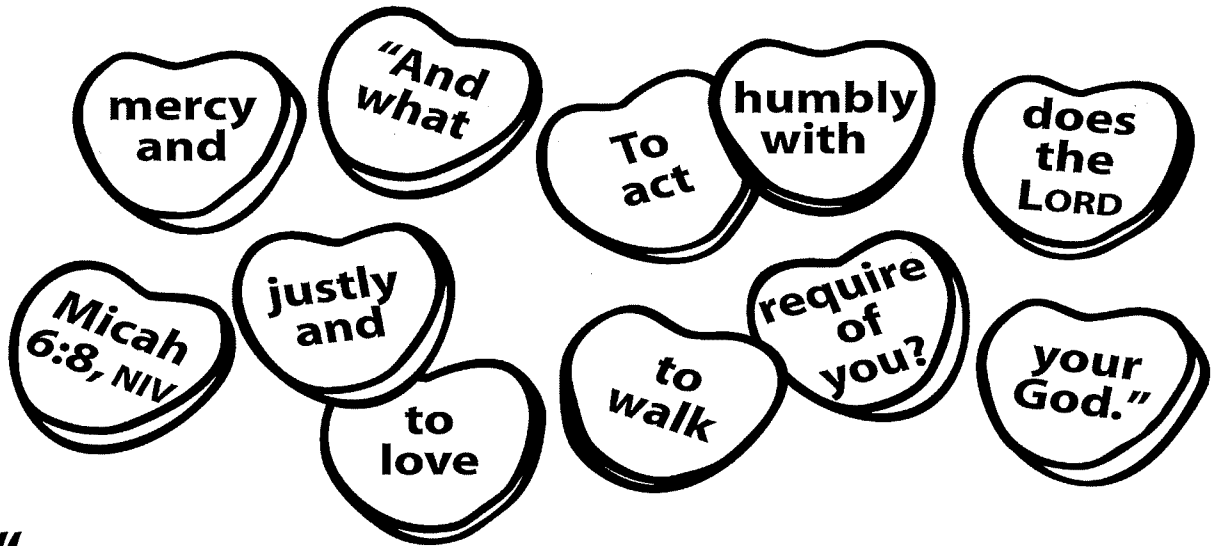

"

_____ ? _____

_____ " _____ 6:8 _____

Answer: "And what does the LORD require of you? To act justly and to love mercy and to walk humbly with your God." Micah 6:8, NIV

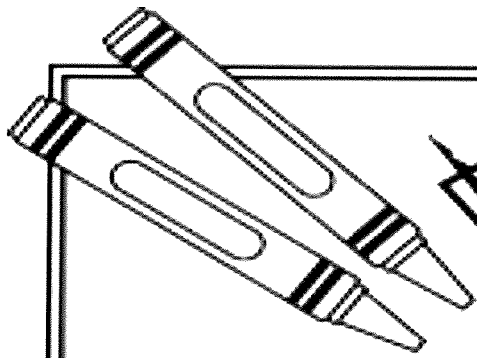

PUZZLE

A NEW COMMANDMENT

In John 13:34, Jesus offers important instructions for his followers.

Directions: Figure out the pattern in each vertical line of letters. Then add the next letter in the sequence to the blank underneath, completing John 13:14, NIV.

ABCDEFGHIJKLMNOPQRSTUVWXYZABCD...

F	L	S	Y	F	K	Y	X	E	I	Q	B	V	O	O	J	F
H	M	T	A	I	L	A	Y	H	K	R	D	Y	P	S	M	G
J	N	U	C	L	M	C	Z	K	M	S	F	B	Q	W	P	H

E	X	M	B	C	L	M	B	U	V	F	R	P	L	V	F	R
F	Y	P	C	F	M	P	C	X	W	I	S	Q	M	W	I	S
G	Z	S	D	I	N	S	D	A	X	L	T	R	N	X	L	T

A	R	J	Q	C	C	S	B	F	K	Y	X	H	L	Q	B	Y	I
E	S	M	R	F	G	T	C	I	L	A	Y	J	M	R	D	A	L
I	T	P	S	I	K	U	D	L	M	C	Z	L	N	S	F	C	O

JOHN 13:34, NIV

Answer: "Love one another. As I have loved you, so you must love one another." John 13:34, NIV

February 2018

SUNDAY	MONDAY	TUESDAY	WEDNESDAY	THURSDAY	FRIDAY	SATURDAY
				1	2	3
4 9:00 Chr Ed 10:00 DW/HC	5	6	7 9:30 Bible Study 4:00 Midweek	8	9	10
11 9:00 Chr. Ed 10:00 DW 11:00 Council Meeting	12	13	14 9:30 Bible Study 11:00 Ash Wed/HC 2:00 Midweek 6:30 Ash Wed/HC	15	16	17
18 9:00 Chr Ed 10:00 DW/HC	19	20	21 9:30 Bible Study 11:00 Lenten Serv 4:00 Midweek 6:30 Lenten Serv	22	23	24
25 9:00 Christian Ed 10:00 DW	26	27	28 9:30 Bible Study 11:00 Lenten Serv 2:00 Midweek 6:30 Lenten Serv			

USHERS

Dwight Ehlers Randy Neumann
 Brian Karus Jake Kraus
 Curtis Ehlers Dale Lenz
 Brad Hinners Zack Kraus
 Colton Neumann Ryan Neumann

CHANCEL CIRCLE

Paulette Von Glan
 Marilyn Mueggenberg
 PARRISH CIRCLE
 Paulette Von Glan
 Marilyn Mueggenberg

MIDWEEK SERVERS

7th: Kendra Schuette
 14th: Jordan Hansen (2pm)
 21st: Jamie Hausman
 24th: Lydia Dose (2 pm)

ACOLYTES

4th: Peyton Henningsen & Jaxson Henningsen
 11th: Sammie Hinners & Kendra Schuette
 18th: Jonathan Dose & Karlie Muhlbauer
 25th: Jordan Hansen & Makayla Schrad

14th: Maggie Ragaller & Danica Ehlers (Wed)
 21st: Damon Ehlers & Emmett Neumann (Wed)
 28th: Bret Hinners & Delaney Schurke (Wed)

Zion Lutheran Church
118 W Tracy St
Box 59
Arcadia, IA 51430
Rev Ben Dose
712-689-2441

Non-Profit Organization
Arcadia, IA 51430
Standard Mail

Friends Who Care

Christian Education 9:00 am
Divine Worship 10:00 am

Friendship Sunday



February 11, 2018